

Description:

-Fabric Armchair, Green color.

Location: Reception**Notes:**

5 years warranty

Dimensions:

50 *25cm - 85cm total height (35cm back height)

Dimensions:

50 *25cm - 85cm total height (35cm back height)

Materials:

Upholstery fabric on 18mm thick HDF wood fixed on metallic legs

Fabric - Green fabric color to match 3D shots



Legs - Silver Stainless Steel

**Material Samples****Sample 1**

Color : Green fabric color to match 3D shots

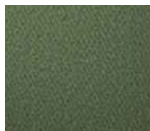

Legs : Silver Stainless Steel



FARAH ARCHITECTS

Project Number 2515	Date July 2025	Scale	Sheet Title Arm Chair	Sheet Number FR-01
Owner			Project Tech - HUB	Reference Number

tel: +962.6.5538569 email: f.haddad@faraharchitects.com www.faraharchitects.com

'HVFULSWLRQ
:RRG 7DEOH

/RFDWLRQ

Notes:

Local,5 \HDUV ZDUUDQW\

'LPHQVLRQV FP FP KHLJK

'LPHQVLRQV
'LD FP FP KHLJK

ODWHULDOV

Top – laminate wood on 18mm
thick HDF wood with EGGER
(1DWXUDO NHQGDO RDN + 67

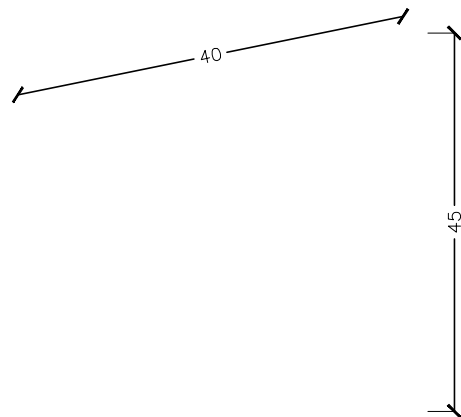

/HJ laminate wood on 18mm
thick HDF wood with EGGER
(1DWXUDO NHQGDO RDN + 67

ODWHULDO 6DPSOHV

6DPSOH

laminate wood on
18mm thick HDF wood
with EGGER (1DWXUDO
NHQGDO RDN +) 67



FARAH ARCHITECTS

Project Number	Date	Scale	Sheet Title	Sheet Number
	July 2025		6CDNG	(4Ä
Owner			Project	Reference Number
			6GEJ Ä *7\$	

WHO

HPDLO I KDGGDG#IDZDZK DDUFBK DWUFRQVW

'HVFULSWLRQ

XSKROVWHUHG WDVN FKDLU 'DUN *UH\)DEULF ZLWK DOXPLQXP SR

/RFDWLRQ

SLVKHG OHJV ZLWK UROOHUV

Notes:

Local,5 \HDUV ZDUUDQW\

'LPHQVLRQ

6HDWLQJ GLPHQVLRQ

FP WRWDO KHLJKW

FP DGMXVWDEOH OHJ KHLJKW

FP EDEN KHLJKW

'LPHQVLRQV

6HDWLQJ GLPHQVLRQ FP

DGMXVWDEOH OHJ KHLJKW FP WRWDO

KHLJKW FP EDEN KHLJKW

ODWHULDOV

XSKROVWHUHG GDUN JUH\ DQG VHDW GDUN

JUH\ IDEULF

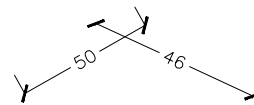

/HJV SROLVKHG DOXPLQXP ZLWK UROOHUV

ODWHULDO 6DPSOHV

6DPSOH

XSKROVWHUHG GDUN JUH\ SROLVKHG DOXPLQXP
VHDW GDUN JUH\ IDEULF UROOHUV



FARAH ARCHITECTS

Project Number	Date	Scale	Sheet Title	Sheet Number
	July 2025		9JGGN %JCKT	(4Ä
Owner			Project	Reference Number
			6GEJ Ä *7\$	

WHO

HPDLO I KDGGDG#IDZDZK DDUF BK DWUFRQW

'HVFULSWLRQ 6RID	/RFDWLRQ open space Notes: Local,5 \H DU V ZDUUDQW\
'LPHQVLRQ VWKRZQ	

'LPHQVLRQV
FP FP FP FP
EDFN KHLJKW FP WRWDO KHLJKW FP
ODWHULDOV
8SKROVWHU\ IDEULF RQ PP WKLFN +')
ZRRG IL[HG RQ PHWDOLF OHJV
)DEULF 'DUN /LJKW *UH\ IDEULF FRORU WR
PDWFK 'V KRWW

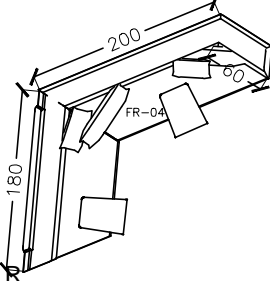
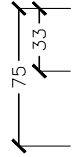
/HJV 6LOYHU 6WDLQOHVV 6WHHO

FXVKLRQV)DEULF :KLWH *UH\ *UHHQ

ODWHULDO 6DP SOHV				
6DP SOH				
'DUN JUH\ IDEULF	/LJKW JUH\ IDEULF	*UHHQ IDEULF	:KLWH IDEULF	/HJV 6LOYHU 6WDLQOHVV 6WHHO

 FARAH ARCHITECTS	Project Number	Date July 2025	Scale	Sheet Title 5QHC	Sheet Number (4Ä)
	Owner		Project 6GEJ Ä *7\$		Reference Number
WHO		HPDLO I KDG G D G # I D Z Z K D D U F B K W U H F R L W M			

'HVFULSWLRQ
)DEULF FKDLU *UHHQ FRORU

/RFDWRS
multi use open space
flexible meeting room/ hall

Notes:

Local,5 \HDUV ZDUUDQW\

'LPHQVLRQV FP FP WRWDO KHLJKW

'LPHQVLRQV
'LD FP FP WRWDO KHLJKW

0DWHULDOV

8SKROVWHU\ IDEULF RQ PP WKLFN +')
ZRRG IL[HG RQ PHWDOLF OHJV

)DEULF *UHHQ IDEULF FRORU WR PDWFK '
VKRWV

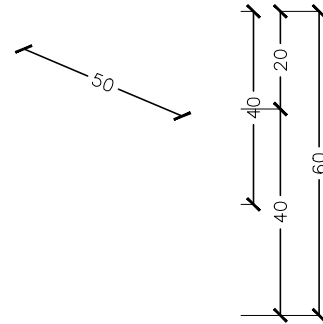

0DWHULDO 6DPSOHV

6DPSOH

&RORU *UHHQ IDEULF FRORU
WR PDWFK 'VKRWV



FARAH ARCHITECTS

Project Number	Date	Scale	Sheet Title	Sheet Number
	July 2025		4QWPF %JCKT	(4Ä
Owner	Project			Reference Number
	6GEJ Ä *7\$			

WHO

HPDLO I KDGGDG#IDZDZ DDUFK K WWHFRLWM

'HVFULSWLRQ
)DEULF FKDLU /LJKW JUH\ FRORU

/RFDWERS
multi use open space
flexible meeting room/ hall

Notes:

Local, 5 \H DU V ZDUUDQW\

'LPHQVLRQV FP FP WRWDO KHLJKW

'LPHQVLRQV
'LD FP FP WRWDO KHLJKW

ODWHULDOV

8SKROVWHU\ IDEULF RQ PP WKLFN +')
ZRRG IL[HG RQ PHWDOLF OHJV

)DEULF /LJKW JUH\ IDEULF FRORU WR PDWFK
'VKRWV

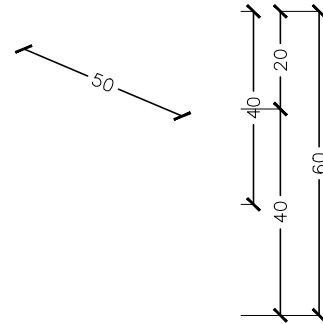

ODWHULDO 6DPSOHV

6DPSOH

&RORU /LJKW JUH\ IDEULF
FRORU WR PDWFK 'VKRWV



FARAH ARCHITECTS

Project Number	Date	Scale	Sheet Title	Sheet Number
	July 2025		4QWPF %JCKT	(4 Ä
Owner	Project			Reference Number
	6GEJ Ä *7\$			

WHO

HPDLO I KDGGDG#IDZDZ DDUF BK DWIFKLVW

'HVFULSWLRQ
7HUUD]]R 7DEOH

/RFDWLRQ open space

Notes:

Local, 5 \HDUV ZDUUDQW\

'LPHQVLRQV FP FP KHLJKW

'LPHQVLRQV
'LD FP FP KHLJKW
0DWHULDOV

7RS 7HUUD]]R

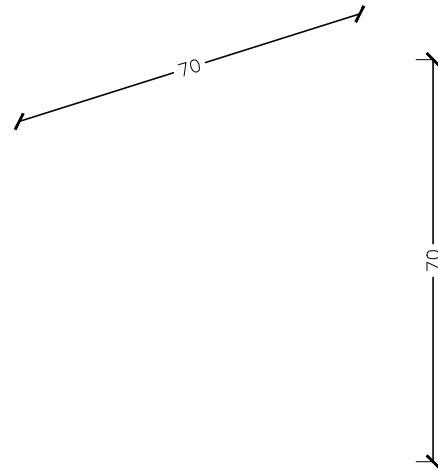

/HJV 6LOYHU 6WDLQOHVV 6WHHO

0DWHULDO 6DP SOHV

6DP SOH	6DP SOH			
7HUUD]]R	/HJV 6LOYHU 6WDLQOHVV 6WHHO			



FARAH ARCHITECTS

Project Number	Date	Scale	Sheet Title	Sheet Number
	July 2025		6CDNG	(4Ä)
Owner			Project	Reference Number
			6GEJ Ä *7\$	

WHO

HPDLO I KDGGDG#IDZDZ DDUFK WUFRWV

'HVFULSWLRQ
:RRG 7DEOH

/RFDWLRQ open space

Notes:

Local,5 \HDUV ZDUUDQW\

'LPHQVLRQV FP FP KHLJKW

'LPHQVLRQV
'LD FP FP KHLJKW

0DWHULDOV

Top – laminate wood on 18mm
thick HDF wood with EGGER

(1DWXUDO NHQGDO RDN + 67

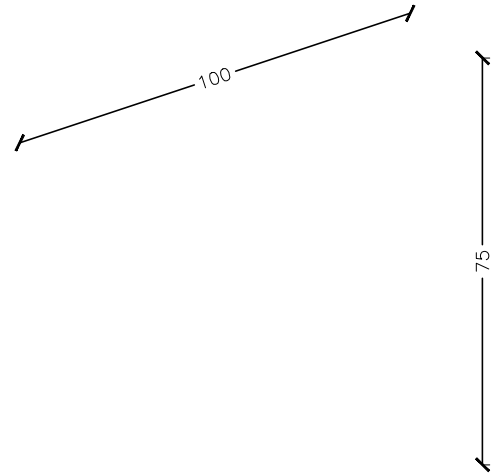

/HJ laminate wood on 18mm
thick HDF wood with EGGER

(1DWXUDO NHQGDO RDN + 67

0DWHULDO 6DPSOHV

6DPSOH

laminate wood on
18mm thick HDF wood
with EGGER (1DWXUDO
NHQGDO RDN +) 67



FARAH ARCHITECTS

Project Number	Date	Scale	Sheet Title	Sheet Number
	July 2025		6CDNG	(4Ä
Owner			Project	Reference Number
			6GEJ Ä *7\$	

WHO

HPDLO I KDGGDG#IDZJZK DDUF BK DWIFRLWM

Description: -Fabric Roller chair, Grey color.		Location: multi use open space
		Notes: 5 years warranty
Dimensions:	50 * 40 cm - 80cm height	

Dimensions:
50 * 40 cm - 80cm height



Materials:

Upholstery fabric on 18mm thick HDF wood fixed on metallic Roller legs

Fabric - Grey fabric color to match 3D shots

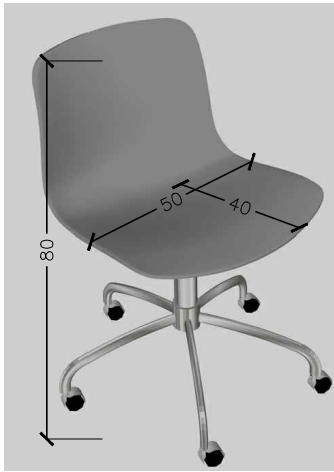

Legs - Silver Stainless Steel

Material Samples				
Sample 1				
Fabric - Grey fabric color to match 3D shots 	Legs - Silver Stainless Steel 			

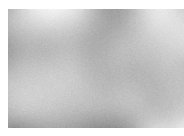

Project Number 2515	Date July 2025	Scale	Sheet Title Chair	Sheet Number FR-10
Owner			Project Tech - HUB	Reference Number

Description:

-Fabric Bench, Beige&Green color.

Location: multi use open space**Notes:**

5 years warranty

Dimensions:

360 * 120cm - 35cm height

Dimensions:

360 * 120cm - 35cm height

Materials:

Upholstery fabric on 18mm thick HDF wood

Fabric - Beige & Green fabric to match 3D shots

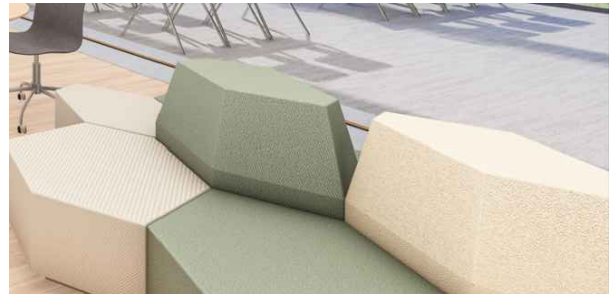
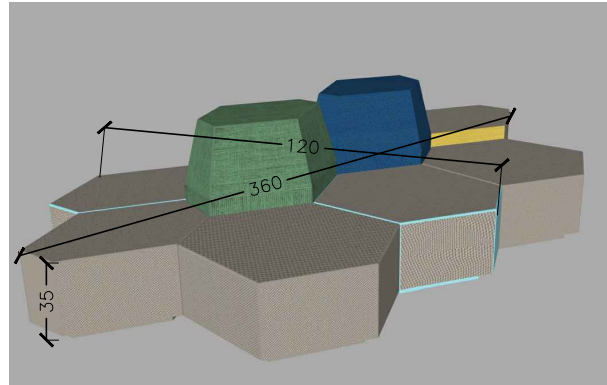
**Material Samples****Sample 1**

Fabric - Green fabric color to match 3D shots



Fabric - Beige fabric color to match 3D shots



FARAH ARCHITECTS

Project Number 2515	Date July 2025	Scale	Sheet Title Bench	Sheet Number FR-11
Owner			Project Tech - HUB	Reference Number

tel: +962.6.5538569 email: f.haddad@faraharchitects.com www.faraharchitects.com

Description:

-Fabric stool chair, Green color.

Location: multi use open space / Cafeteria area**Notes:**

5 years warranty

Dimensions:

42 * 45 cm - 90cm height

Dimensions:

42 * 45 cm - 90cm height

Materials:Upholstery fabric on 18mm thick HDF
wood fixed on metallic legsFabric - Green fabric color to match 3D
shots

Legs - Silver Stainless Steel

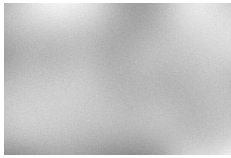
**Material Samples****Sample 1**Fabric - Green fabric color
to match 3D shots

Legs - Silver Stainless Steel



FARAH ARCHITECTS

Project Number 2515	Date July 2025	Scale	Sheet Title Stool Chair	Sheet Number FR-12
Owner			Project Tech - HUB	Reference Number

tel: +962.6.5538569 email: f.haddad@faraharchitects.com www.faraharchitects.com

Description: -Fabric chair, Grey color.		Location: multi use open space
Dimensions: 48 * 40 cm - 98cm height		Notes: 5 years warranty

Dimensions:
48 * 40 cm - 98cm height



Materials:



Upholstery fabric on 18mm thick HDF wood fixed on metalic legs

Fabric - Grey fabric color to match 3D shots

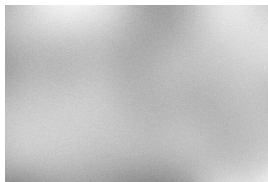
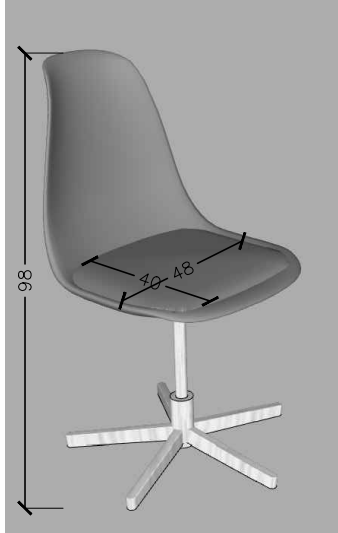

Legs - Silver Stainless Steel

Material Samples				
Sample 1				
Fabric - Green fabric color to match 3D shots 	Legs - Silver Stainless Steel 			

F FARAH ARCHITECTS	Project Number	Date	Scale	Sheet Title	Sheet Number
	2515	July 2025		Chair	FR-13
	Owner				Reference Number
				Project	
				Tech - HUB	
tel: +962.6.5538569 email: f.haddad@faraharchitects.com www.faraharchitects.com					

Description: -Wood Table		Location: multi use open space
		Notes: 5 years warranty
Dimensions:	188* 60 cm - 78cm height	



Dimensions:
188* 60 cm - 78cm height

Materials:

Top - laminate wood on 18mm thick HDF wood with EGGER (Natural kendal oak H3170 ST12)

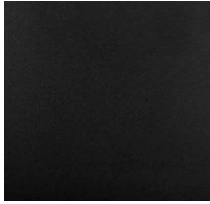
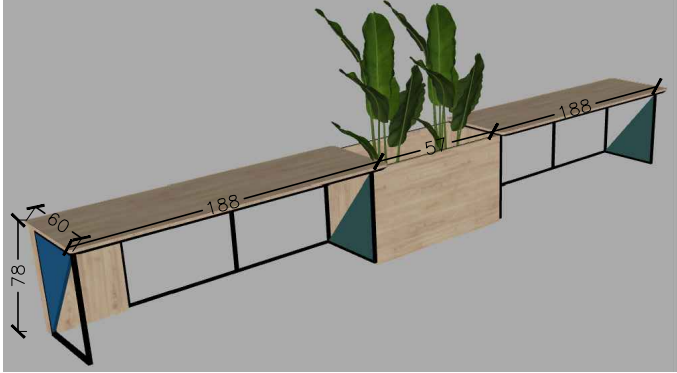

Legs - Black Metal

Material Samples				
Sample 1				
laminate wood on 18mm thick HDF wood with EGGER (Natural kendal oak H3170 ST12) 	Legs - Black Metal 			

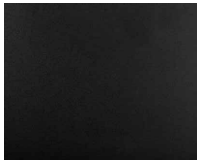

Project Number 2515	Date July 2025	Scale	Sheet Title Table	Sheet Number FR-14
Owner			Project Tech - HUB	Reference Number

Description:

-Wood Table

Location: multi use open space**Notes:**

5 years warranty

Dimensions:

Dia 68 cm - 45cm heigh

Dimensions:

Dia 68 cm - 45cm heigh

Materials:

Top – laminate wood on 18mm thick HDF wood with EGGER (Natural kendal oak H3170 ST12)

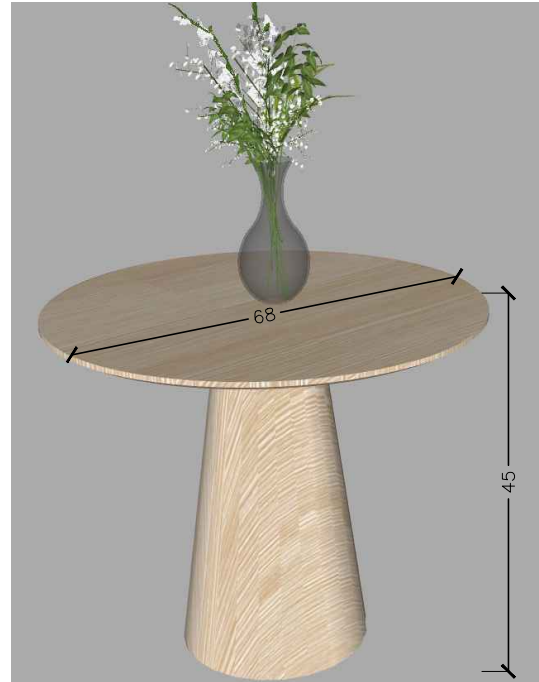

Leg - laminate wood on 18mm thick HDF wood with EGGER (Natural kendal oak H3170 ST12)

**Material Samples****Sample 1**

laminate wood on 18mm thick HDF wood with EGGER (Natural kendal oak H3170 ST12)



FARAH ARCHITECTS

Project Number 2515	Date July 2025	Scale	Sheet Title Table	Sheet Number FR-15
Owner			Project Tech - HUB	Reference Number

tel: +962.6.5538569 email: f.haddad@faraharchitects.com www.faraharchitects.com



Description: -Fabric Single Bench , Grey color.		Location: Flexible meeting room/ hall
		Notes: 5 years warranty
Dimensions:	42 * 42 cm - 48cm total height	

Dimensions:
42 * 42 cm - 48cm total height

Materials:

Upholstery fabric on 18mm thick HDF wood

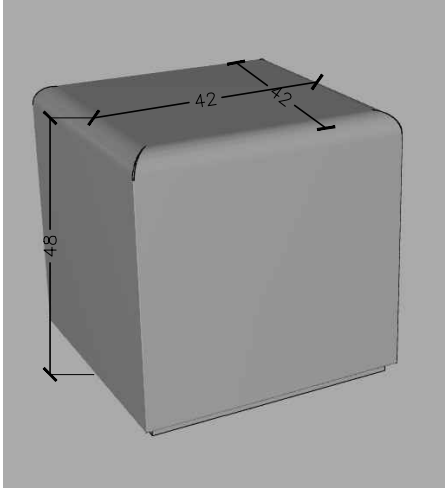
Fabric - Grey fabric color to match 3D shots

Material Samples				
Sample 1				
Color : Grey fabric color to match 3D shots				
				

F FARAH ARCHITECTS	Project Number	Date	Scale	Sheet Title	Sheet Number
	2515	July 2025		Bench	FR-16
	Owner	Project			Reference Number
	Tech - HUB				
tel: +962.6.5538569 email: f.haddad@faraharchitects.com www.faraharchitects.com					

Description: -Fabric Single Bench, White color.		Location: Flexible meeting room/ hall
		Notes: 5 years warranty
Dimensions:	42 * 42 cm - 48cm total height	

Dimensions:
42 * 42 cm - 48cm total height

Materials:

Upholstery fabric on 18mm thick HDF wood

Fabric - White fabric color to match 3D shots

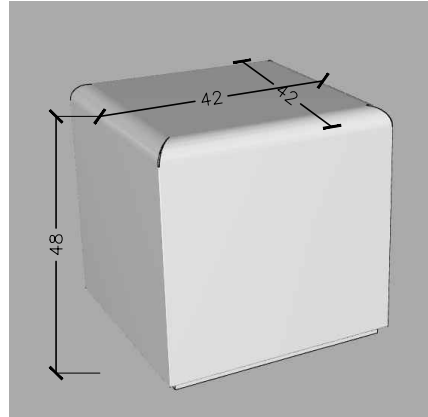

Material Samples

Sample 1				
Color : White fabric color to match 3D shots 				



FARAH ARCHITECTS

Project Number 2515	Date July 2025	Scale	Sheet Title Bench	Sheet Number FR-17
Owner			Project Tech - HUB	Reference Number

tel: +962.6.5538569 email: f.haddad@faraharchitects.com www.faraharchitects.com

Description:

-Fabric armchair, Blue color.

Location: Flexible meeting room/ hall**Notes:**

5 years warranty

Dimensions:

70 * 66 cm - 100cm total height

Dimensions:

70 * 66 cm - 100cm total height

Materials:

Upholstery fabric on 18mm thick HDF wood fixed on metallic legs

Fabric - Blue fabric color to match 3D shots

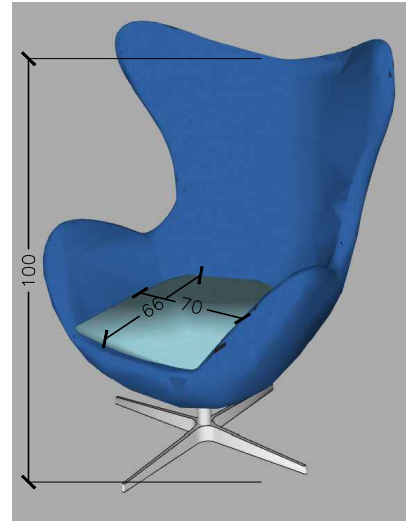

Legs - White Metal

**Material Samples****Sample 1**

Color : Blue fabric color to match 3D shots



Legs - White Metal



FARAH ARCHITECTS

Project Number 2515	Date July 2025	Scale	Sheet Title Chair	Sheet Number FR-18
Owner			Project Tech - HUB	Reference Number

tel: +962.6.5538569 email: f.haddad@faraharchitects.com www.faraharchitects.com

Description:

-Fabric Armchair, Grey color.

Location: multi use open space**Notes:**

5 years warranty

Dimensions:

50 *25cm - 85cm total height (35cm back height)

Dimensions:

50 *25cm - 85cm total height (35cm back height)

Materials:

Upholstery fabric on 18mm thick HDF wood fixed on metallic legs

Fabric - Grey fabric color to match 3D shots

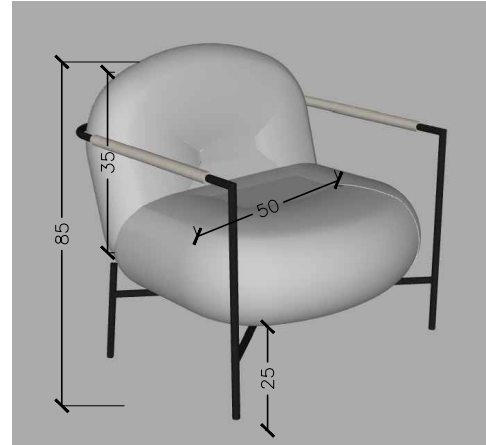
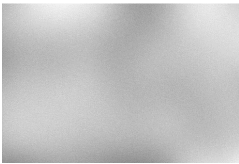

Legs - Silver Stainless Steel

**Material Samples****Sample 1**

Color : Grey fabric color to match 3D shots



Legs : Silver Stainless Steel



FARAH ARCHITECTS

Project Number 2515	Date July 2025	Scale	Sheet Title Arm Chair	Sheet Number FR-19
Owner			Project Tech - HUB	Reference Number

tel: +962.6.5538569 email: f.haddad@faraharchitects.com www.faraharchitects.com

Description:

-Fabric Pouff, Grey color.

Location: multi use open space /
Flexible meeting room/ hall**Notes:**

5 years warranty

Dimensions:

63 *65cm - 50cm total height

Dimensions:

63 *65cm - 50cm total height

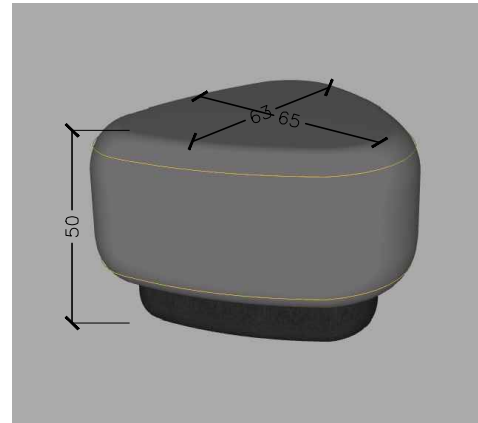
Materials:Upholstery fabric on 18mm thick HDF
woodFabric - Grey fabric color to match 3D
shots**Material Samples****Sample 1**Color : Grey fabric color to
match 3D shots

FARAH ARCHITECTS

Project Number 2515	Date July 2025	Scale	Sheet Title Fabric Pouff	Sheet Number FR-20
Owner			Project Tech - HUB	Reference Number

tel: +962.6.5538569 email: f.haddad@faraharchitects.com www.faraharchitects.com

Description:

-Wood Table with side cabinets

Location: offices area**Notes:**

5 years warranty

Dimensions:

160* 70 cm - 75cm height

Dimensions:

160* 70 cm - 75cm height

Materials:

Top - laminate wood on 18mm thick HDF wood with EGGER (Natural kendal oak H3170 ST12)

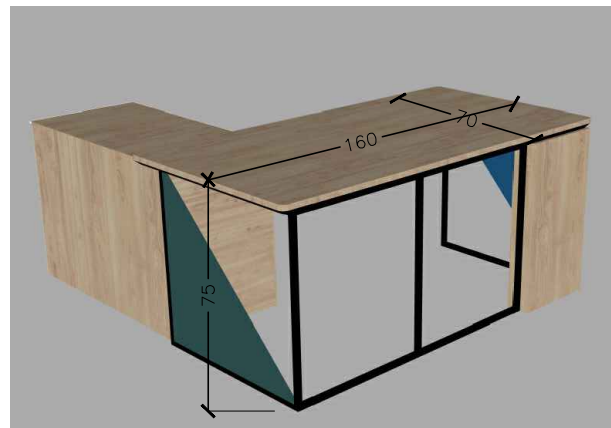
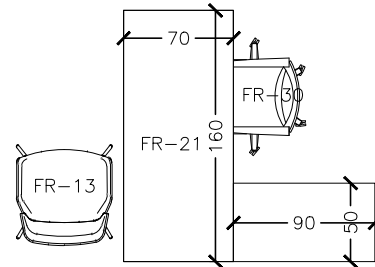
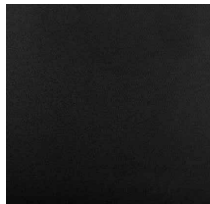

Legs - Black Metal

**Material Samples****Sample 1**

laminate wood on 18mm thick HDF wood with EGGER (Natural kendal oak H3170 ST12)



Legs - Black Metal

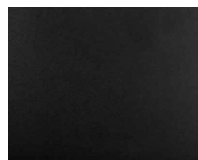

FARAH ARCHITECTS

Project Number	Date	Scale	Sheet Title	Sheet Number
2515	July 2025		Table	FR-21
Owner	Project			Reference Number
	Tech - HUB			

tel: +962.6.5538569 email: f.haddad@faraharchitects.com www.faraharchitects.com

Description:

-Fabric stool chair, light yellow color.

Location: hall for 50 person

Notes:

5 years warranty

Dimensions:

42 * 45 cm - 90cm height

Dimensions:

42 * 45 cm - 90cm height

Materials:

Upholstery fabric on 18mm thick HDF wood fixed on metallic legs

Fabric - Light yellow fabric color to match 3D shots

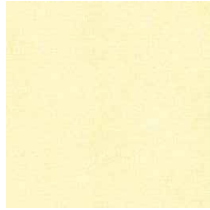

Legs - corten steel

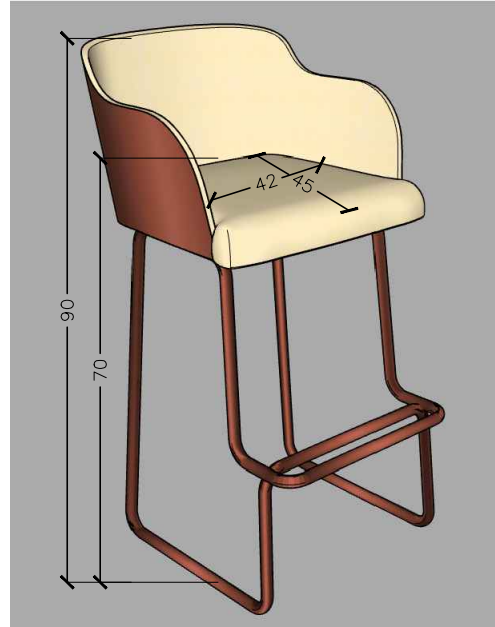

Material Samples

Sample 1

Fabric - Light yellow fabric color to match 3D shots



Legs - corten steel



FARAH ARCHITECTS

Project Number 2515	Date July 2025	Scale	Sheet Title Stool Chair	Sheet Number FR-22
Owner			Project Tech - HUB	Reference Number

tel: +962.6.5538569 email: f.haddad@faraharchitects.com www.faraharchitects.com

Description:

Terrazzo high Table

Location: multi use open space**Notes:**

5 years warranty

Dimensions:

277 cm * 70 cm - 90cm height

Dimensions:

277 cm * 70 cm - 90cm height

Materials:

Top - Terrazzo



Legs - Corten Steel

**Material Samples****Sample 1****Sample 2**

Terrazzo

Legs - Corten Steel



FARAH ARCHITECTS

Project Number	Date	Scale	Sheet Title	Sheet Number
2515	July 2025		Table	FR-23
Owner	Project			Reference Number
	Tech - HUB			

tel: +962.6.5538569 email: f.haddad@faraharchitects.com www.faraharchitects.com

Description:

-Fabric Pouff, Grey color.

Location: Flexible meeting room/ hall

Notes:

5 years warranty

Dimensions:

55 *58cm - 50cm total height

Dimensions:

55 *58cm - 50cm total height

Materials:

Upholstery fabric on 18mm thick HDF wood

Fabric - Grey fabric color to match 3D shots

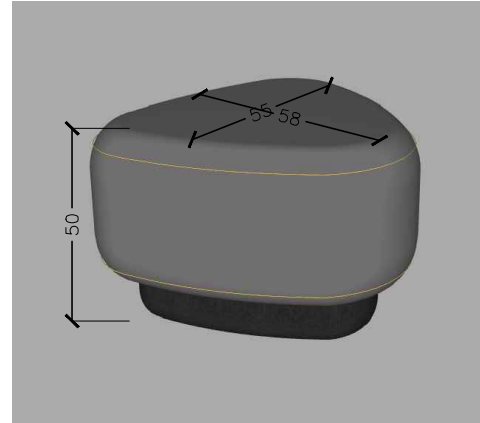

Material Samples

Sample 1

Color : Grey fabric color to match 3D shots



FARAH ARCHITECTS

Project Number 2515	Date July 2025	Scale	Sheet Title Fabric Pouff	Sheet Number FR-24
Owner			Project Tech - HUB	Reference Number

tel: +962.6.5538569 email: f.haddad@faraharchitects.com www.faraharchitects.com

Description:

-Fabric Pouff, White color.

Location: Flexible meeting room/ hall**Notes:**

5 years warranty

Dimensions:

70 *65cm - 50cm total height

Dimensions:

70 *65cm - 50cm total height

Materials:

Upholstery fabric on 18mm thick HDF wood

Fabric - White fabric color to match 3D shots

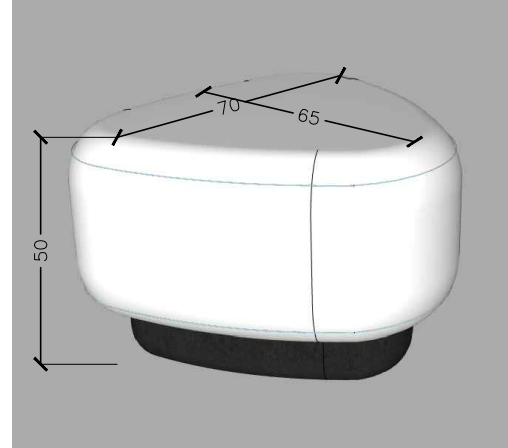
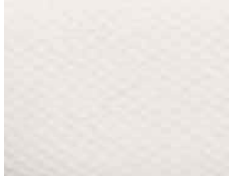
**Material Samples****Sample 1**

Color : White fabric color to match 3D shots

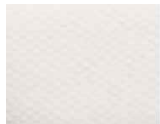

FARAH ARCHITECTS

Project Number 2515	Date July 2025	Scale	Sheet Title Fabric Pouff	Sheet Number FR-25
Owner			Project Tech - HUB	Reference Number

tel: +962.6.5538569 email: f.haddad@faraharchitects.com www.faraharchitects.com

Description:

-Chair, Grey color.

Location: Flexible meeting room/ hall**Notes:**

5 years warranty

Dimensions:

43 *41 cm - 80 cm total height (40cm back height)

Dimensions:

43 *41 cm - 80 cm total height (40cm back height)

Materials:

Upholstery fabric on 18mm thick HDF wood fixed on metallic legs

Fabric - Grey fabric color to match 3D shots

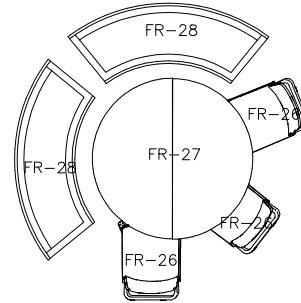
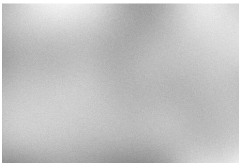

Legs - Silver Stainless Steel

**Material Samples****Sample 1**

Color : Grey fabric color to match 3D shots



Legs : Silver Stainless Steel



FARAH ARCHITECTS

Project Number 2515	Date July 2025	Scale	Sheet Title Chair	Sheet Number FR-26
Owner			Project Tech - HUB	Reference Number

tel: +962.6.5538569 email: f.haddad@faraharchitects.com www.faraharchitects.com

Description: Table		Location: Flexible meeting room/ hall
		Notes: 5 years warranty
Dimensions:	Dia 120 cm - 68cm height	

Dimensions:
Dia 120 cm - 68cm height

Materials:



Top - Wood painted white

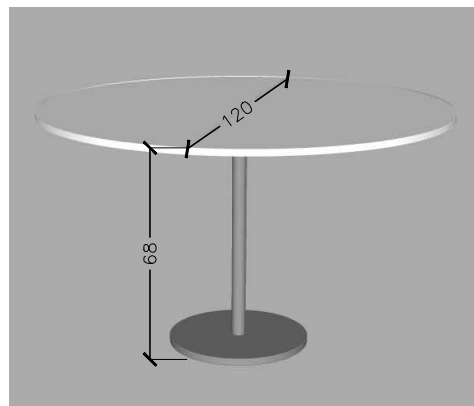
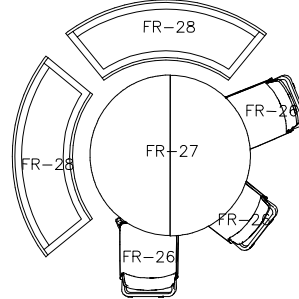

Legs - Silver Stainless Steel



Material Samples

Sample 1	Sample 2			
Top - Wood painted white	Legs - Silver Stainless Steel			
				



FARAH ARCHITECTS

Project Number 2515	Date July 2025	Scale	Sheet Title Table	Sheet Number FR-27
Owner			Project Tech - HUB	Reference Number

tel: +962.6.5538569 email: f.haddad@faraharchitects.com www.faraharchitects.com

Description:

-FabricBench, Beige&Green color.

Location: Flexible meeting room/ hall**Notes:**

5 years warranty

Dimensions:

120 * 40cm (20 cm back height) - 62 cm total height

Dimensions:

120 * 40cm (20 cm back height) - 62 cm total height

Materials:

Upholstery fabric on 18mm thick HDF wood with wheels

Fabric - Beige & Green fabric to match 3D shots

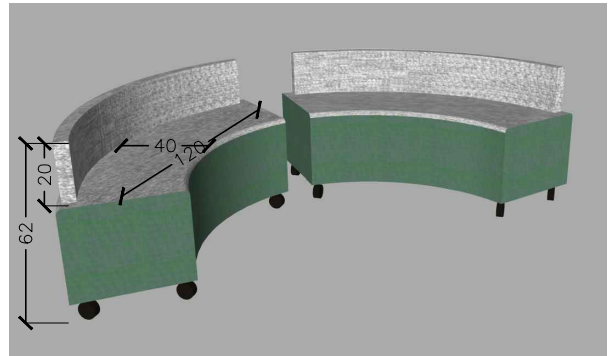
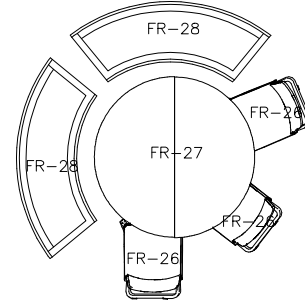
**Material Samples****Sample 1**

Fabric - Green fabric color to match 3D shots

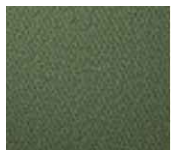

Fabric - Beige fabric color to match 3D shots



FARAH ARCHITECTS

Project Number 2515	Date July 2025	Scale	Sheet Title Chair	Sheet Number FR-28
Owner			Project Tech - HUB	Reference Number

tel: +962.6.5538569 email: f.haddad@faraharchitects.com www.faraharchitects.com

Description:

-Fabric Sofa , Grey color.

Location: Flexible meeting room/ hall**Notes:**

5 years warranty

Dimensions:

70 *65cm per seat - 72cm total height (32cm back height)

Dimensions:70 *65cm per seat - 72cm total height
(32cm back height)**Materials:**Upholstery fabric on 18mm thick HDF
wood fixed on metallic legsFabric - Grey fabric color to match 3D
shots

Cushions - Grey & Green Fabric

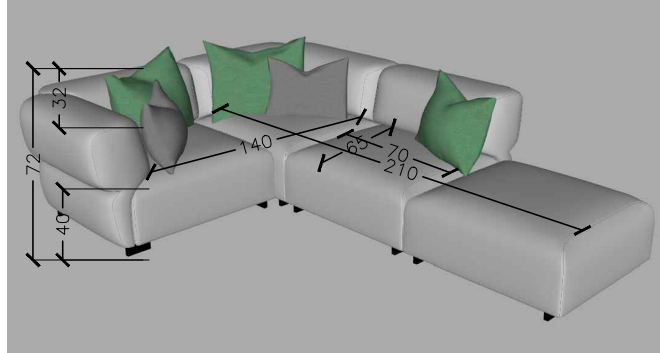
**Material Samples****Sample 1**Color : Grey fabric color to
match 3D shots

Cushions - Grey Fabric



Cushions - Green Fabric



FARAH ARCHITECTS

Project Number 2515	Date July 2025	Scale	Sheet Title Sofa	Sheet Number FR-29
Owner			Project Tech - HUB	Reference Number

tel: +962.6.5538569 email: f.haddad@faraharchitects.com www.faraharchitects.com

Description:

-Fabric chair, Grey color.

Location: offices area / phone booth**Notes:**

5 years warranty

Dimensions:

47 * 40 cm - (back height 45 cm) - Total height 105 cm

Dimensions:

47 * 40 cm - (back height 45 cm) - Total height 105 cm

Materials:

Upholstery fabric on 18mm thick HDF wood fixed on metallic legs

Fabric - Grey fabric color to match 3D shots



Legs - Silver Stainless Steel

**Material Samples****Sample 1**

Fabric - Grey fabric color to match 3D shots



Legs - Silver Stainless Steel



FARAH ARCHITECTS

Project Number 2515	Date July 2025	Scale	Sheet Title Chair	Sheet Number FR-30
Owner			Project Tech - HUB	Reference Number

tel: +962.6.5538569 email: f.haddad@faraharchitects.com www.faraharchitects.com

Description: colored seating bench		Location: hall for 50 person
		Notes: 5 years warranty
Dimensions:	180*60 cm *40cm height	

Dimensions:
180*60 cm *40cm height

Bench Upholstery fabric on 18mm thick
HDF wood fixed on metallic legs

Materials:

green fabric



Legs - silver stainless steel

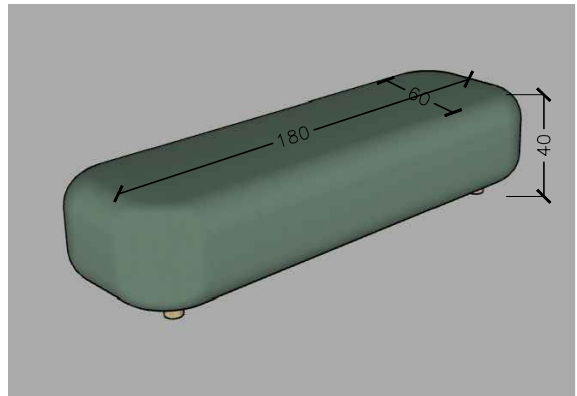
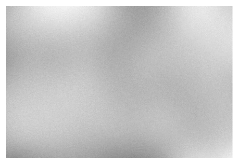

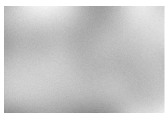
Material Samples				
Sample 1	Sample 2			
green fabric color	Legs - silver stainless steel			
				



FARAH ARCHITECTS

Project Number 2515	Date July 2025	Scale	Sheet Title Bench	Sheet Number FR-31
Owner			Project Tech - HUB	Reference Number

Description:

side table

Location: hall for 50 person**Notes:**

5 years warranty

Dimensions:

As shown

Dimensions:

Top 55cm diameter
 Base 30cm diameter
 leg 50cm height
 total height 60cm

Materials: Metal painted yellow

Top: Metal painted yellow



Base: Metal painted yellow

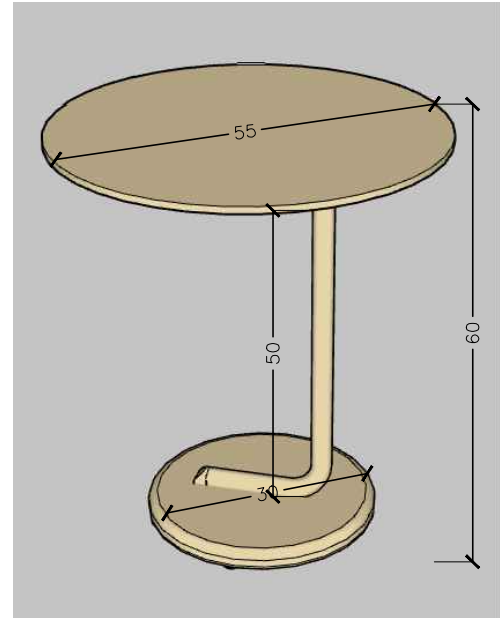

legs - Metal painted yellow

**Material Samples****Sample 1**

Metal painted yellow

**FARAH ARCHITECTS**

Project Number 2515	Date July 2025	Scale	Sheet Title Side table	Sheet Number FR-32
Owner			Project Tech - HUB	Reference Number

tel: +962.6.5538569 email: f.haddad@faraharchitects.com www.faraharchitects.com

Description:

table

Location: hall for 50 person

Notes:

5 years warranty

Dimensions:

As shown

Dimensions:

Top 90cm diameter
Base 40cm diameter
total height 70cm

Materials: Metal painted grey

Top: Metal painted grey



Base: Metal painted grey



legs - Metal painted grey

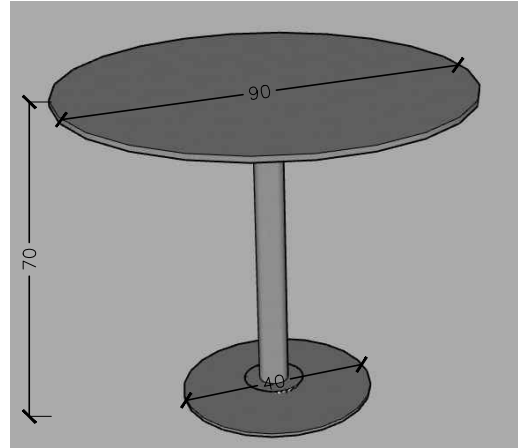

Material Samples

Sample 1

Metal painted grey



FARAH ARCHITECTS

Project Number 2515	Date July 2025	Scale	Sheet Title Side table	Sheet Number FR-33
Owner			Project Tech - HUB	Reference Number

tel: +962.6.5538569 email: f.haddad@faraharchitects.com www.faraharchitects.com

Description:

-Swivel Chair, light yellow color.

Location: hall for 50 person**Notes:**

5 years warranty

Dimensions:

40 cm * 40 cm (back height 20cm) - 70cm total height

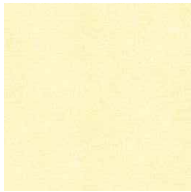
Dimensions:40 cm * 40 cm (back height 20cm) -
70cm total height**Materials:**Upholstery fabric on 18mm thick HDF
wood fixed on metallic legsFabric - Light yellow fabric color to
match 3D shots

Legs - silver stainless steel

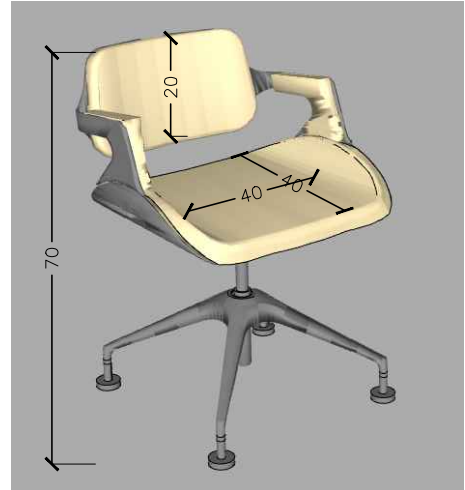
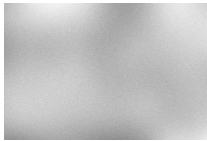
**Material Samples****Sample 1**Fabric - Light yellow fabric
color to match 3D shots

Legs - silver stainless steel



FARAH ARCHITECTS

Project Number 2515	Date July 2025	Scale	Sheet Title Swivel Chair	Sheet Number FR-34
Owner			Project Tech - HUB	Reference Number

tel: +962.6.5538569 email: f.haddad@faraharchitects.com www.faraharchitects.com

Description:

-Swivel Chair, light blue color.

Location: hall for 50 person**Notes:**

5 years warranty

Dimensions:

40 cm * 40 cm (back height 20cm) - 70cm total height

Dimensions:40 cm * 40 cm (back height 20cm) -
70cm total height**Materials:**Upholstery fabric on 18mm thick HDF
wood fixed on metallic legsFabric - Light blue fabric color to match
3D shots

Legs - silver stainless steel

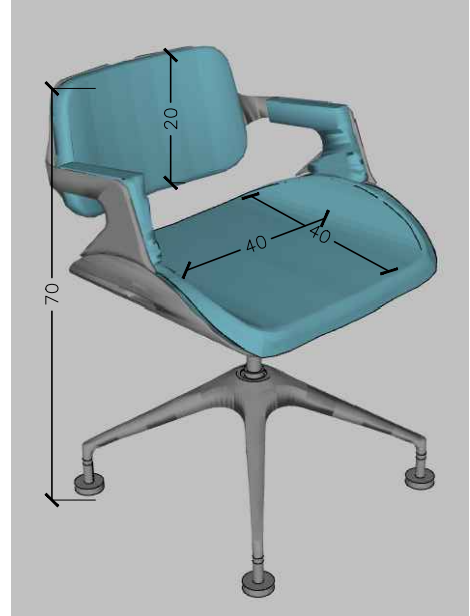
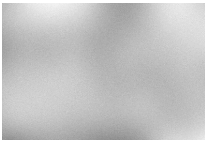
**Material Samples****Sample 1**Fabric - Light blue fabric
color to match 3D shots

Legs - silver stainless steel

**FARAH ARCHITECTS**

Project Number 2515	Date July 2025	Scale	Sheet Title Swivel Chair	Sheet Number FR-35
Owner			Project Tech - HUB	Reference Number

tel: +962.6.5538569 email: f.haddad@faraharchitects.com www.faraharchitects.com

Description:

colored seating bench

Location: hall for 50 person**Notes:**

5 years warranty

Dimensions:

as shown

Dimensions:

Green 180*60 cm *40cm height
 light yellow 120*60 cm * 60cm height
 grey (1) 180*120 cm *40cm height
 grey (2) 240* 120 cm *40cm height

Bench Upholstery fabric on 18mm thick
 HDF wood fixed on metallic legs

Materials:

grey Fabric



green fabric



light yellow fabric

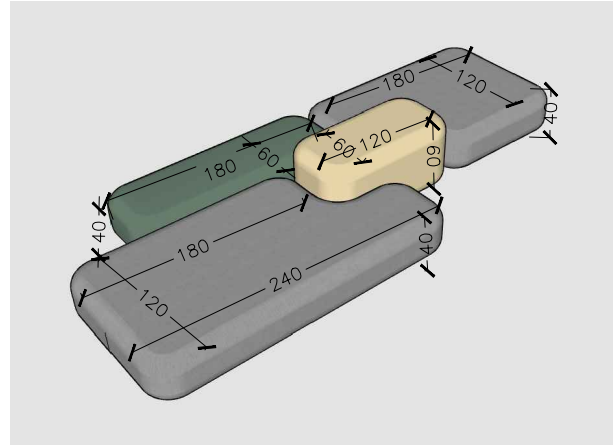

Legs - silver stainless steel

**Material Samples****Sample 1**

grey fabric color

**Sample 2**

green fabric color



light yellow fabric color



Legs - silver stainless steel



FARAH ARCHITECTS

Project Number 2515	Date July 2025	Scale	Sheet Title Bench	Sheet Number FR-36
Owner			Project Tech - HUB	Reference Number

tel: +962.6.5538569 email: f.haddad@faraharchitects.com www.faraharchitects.com

Description:

side table

Location: hall for 50 person**Notes:**

5 years warranty

Dimensions:

As shown

Dimensions:

Top 55cm diameter
 Base 30cm diameter
 leg 50cm height
 total height 60cm

Materials: Metal painted light blue

Top: Metal painted light blue



Base: Metal painted light blue

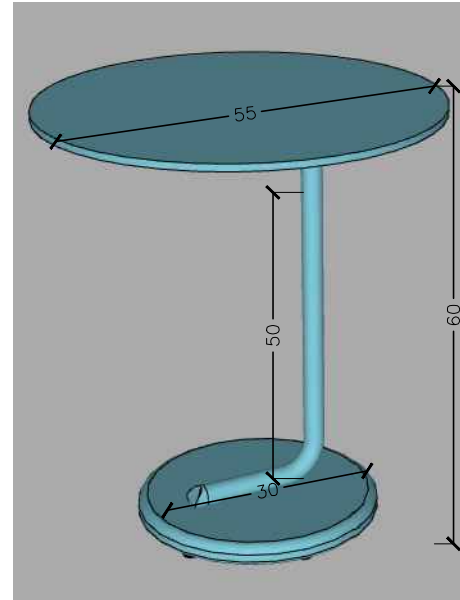

legs - Metal painted light blue

**Material Samples****Sample 1**

Metal painted light blue

**FARAH ARCHITECTS**

Project Number 2515	Date July 2025	Scale	Sheet Title Side table	Sheet Number FR-37
Owner			Project Tech - HUB	Reference Number

tel: +962.6.5538569 email: f.haddad@faraharchitects.com www.faraharchitects.com

Description: -Fabric single Pouff, Green color.		Location: hall for 50 person
		Notes: 5 years warranty
Dimensions:	Dia 50 cm - 50 cm total height	

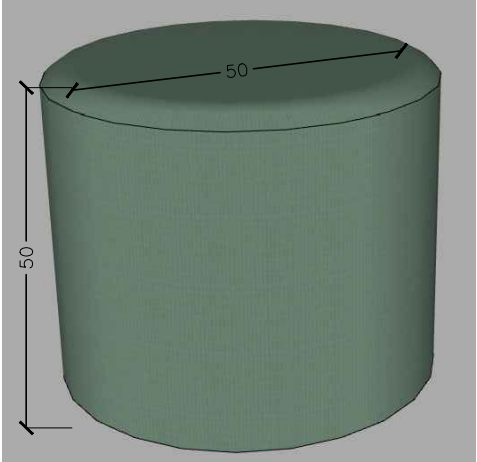
<p>Dimensions: Dia 50 cm - 50 cm total height</p> <p>Materials:</p> <p>Upholstery fabric on 18mm thick HDF wood fixed on metallic legs</p> <p>Fabric - Green fabric color to match 3D shots</p> 	
--	--

Material Samples				
Sample 1				
Color : Green fabric color to match 3D shots 				

 FARAH ARCHITECTS	Project Number	Date	Scale	Sheet Title	Sheet Number
	2515	July 2025		Round Pouff	FR-38
	Owner	Project			Reference Number
		Tech - HUB			
tel: +962.6.5538569 email: f.haddad@faraharchitects.com www.faraharchitects.com					

Description:

colored seating bench

Location: hall for 50 person**Notes:**

5 years warranty

Dimensions:

as shown

Dimensions:

Green 87*45 cm *40cm height

light yellow 87*45 cm * 40cm height

grey 60*55 cm *50cm height

Bench Upholstery fabric on 18mm thick
HDF wood**Materials:**

grey Fabric



green fabric

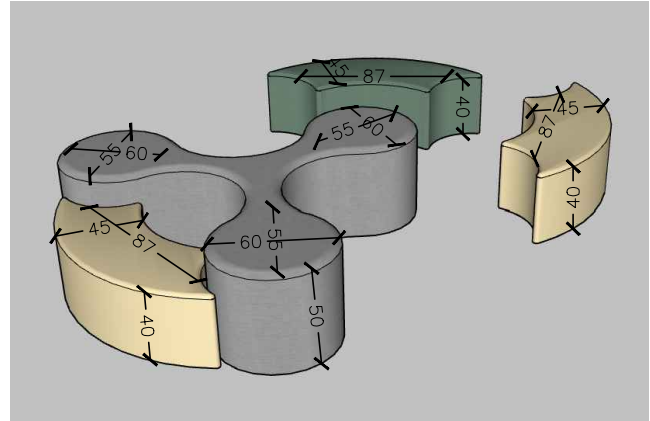

light yellow fabric

**Material Samples****Sample 1**

grey fabric color

**Sample 2**

green fabric color



light yellow fabric color



FARAH ARCHITECTS

Project Number 2515	Date July 2025	Scale	Sheet Title Bench	Sheet Number FR-39
Owner			Project Tech - HUB	Reference Number

tel: +962.6.5538569 email: f.haddad@faraharchitects.com www.faraharchitects.com